



Explosion Proof Light B Series



Industrial Field & Hazardous Locations

Applications

Oil and Gas industry

- All petroleum production and refining
- Petroleum loading and transportation
- Petroleum storage and retail
- LNG industry

- All mining operations and service

Chemical industry

- All types of paint facilities
- Chemical production and storage

Ocean, marine and aerospace field

- Ocean platform operation facilities and structure
- Aerospace clean room and production
- Ocean vessel operations

Metal treatment

- Steel and aluminum factories
- Pumping stations in any environment
- Metal smelting, foundry and fabrication

Food and alcohol industry

- Flour and fine particle production and storage
- Food and distilling production
- Alcohol industry

Other high humidity, high dust, high temperature, vapor locations





B2



B



B3



B4



Explosion Protection

Marking Atex

II2 G Ex mb eb IIC T4 Gb
II2 D Ex tb IIIC T135C Db IP66
II3 G Ex ec IIC T3C Gc
II2 D Ex tb IIIC T135C Db IP66

Marking IECEX

Ex mb eb IIC T4 Gb
Ex tb IIIC T135C Db IP66
Ex ec IIC T3C Gc
Ex tb IIIC T135C Db Ip66

Materials

- Housing: Aluminum
- Lens: Tempered glass

Marking UL844 (North American)

Class I, Division 2, Groups A, B, C, D
Class II, Division 1, Groups E, F, G
Class II, Division 2, Groups F, G
Class III

Marine Marking

UL1598, UL1598A
ABS

Other Rating

IP 66

- Hardware: stainless steel
- Mounting Bracket: stainless steel

Features

- Working Temperature: -40°C ~ +55°C.
- High quality SMT LED and Meanwell Driver.
- Light-weight design by aircraft aluminum.
- Heavy-duty and high impact resistance.
- Three connection cable entry points.
- Replaceable LED board and drivers.
- Integrated junction box for driver with emergency back up.
- Dimmable and battery back up function available.
- Marine rating powder coated appearance treatment.
- Up to 5 years limited warranty option.
- Emergency Battery back up to three hours.
- Various installation ways for different applications.
- Glass lens or Glass with polycarbonate lens to make bigger beam angle.

Light Distribution

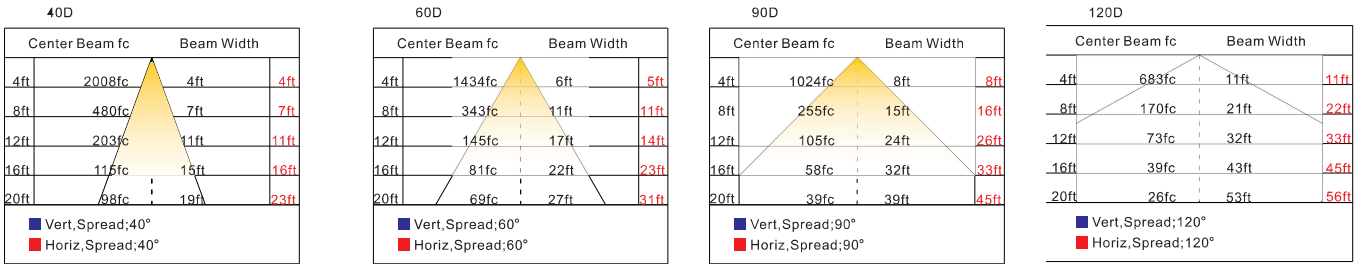

Specification

Product Number	Wattage	Color Temperature	Voltage	Lumens	Warranty	CRI
EX-20W B2YZDA	20	2200K-7000K	AC100-277V(by driver or by IC) Or DC12-48V	2800	5 years	80
EX-40W B2YZDA	40			5600		
EX-60W BYZDA	60		AC100-277V(by driver or by IC) Or DC12-48V	8400		
EX-80W BYZDA	80			11200		
EX-100W B3YZDA	100		AC100-277V(by driver or by IC) Or DC12-48V Or AC200-480V(<65W)	14000		
EX-120W B3YZDA	120			16800		
EX-150W B3YZDA	150			21000		
EX-200W B3YZDA	200			28000		
EX-250W B4YZDA	250			35000		
EX-300W B4YZDA	300			42000		
EX-350W B4YZDA	350			49000		
EX-400W B4YZDA	400			56000		

Packing Information

Model	Quantity/Carton	Length(cm)	Width(cm)	Height(cm)	Net weight(kg)	Gross weight(kg)
B	1	38.6	33	22	4.4	5.5
B2	1	36	35.4	26	3.5	5
B3	1	48	46	26.5	8.2	10.5
B4	1	53	53	44	18.8	21.5

Dimension

Model B2

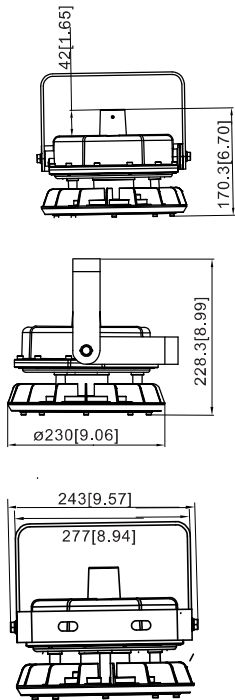

Model B

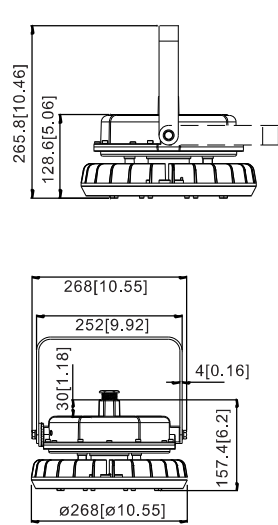

Model B3

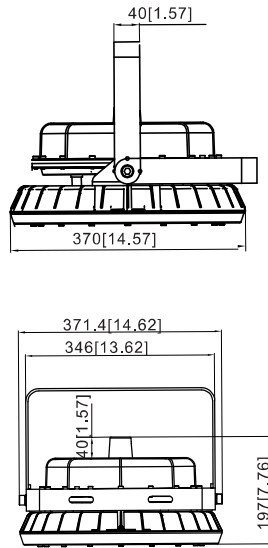

Model B4

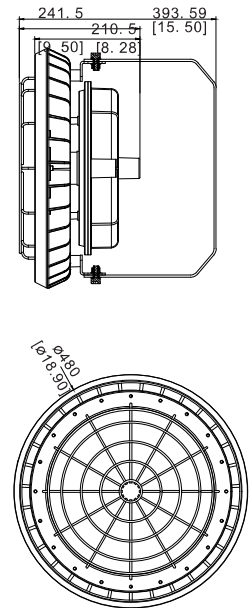

Mounting

No.1: Ceiling Mounting

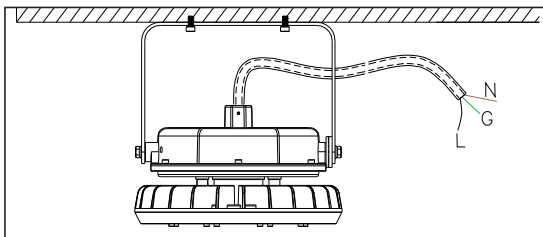

No.2: Wall Mounting

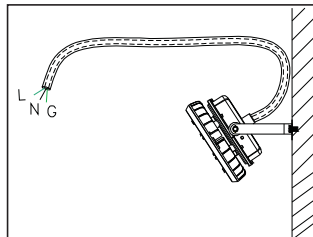

No.3: Pole Pendant

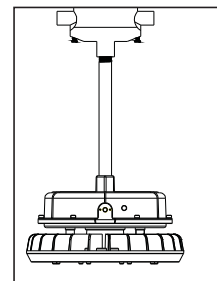

No.4: Hook Pendant

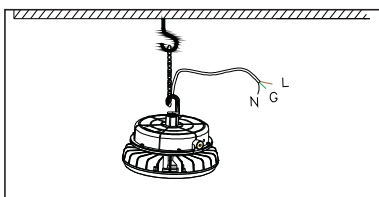

No.6: Arm Mounting by Opening Driver Box

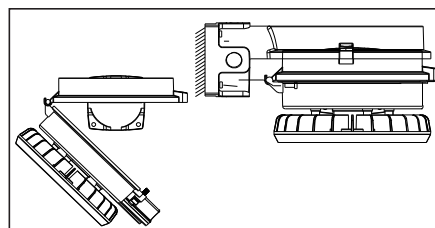

No.5: Ceiling Mounting by Opening Driver Box

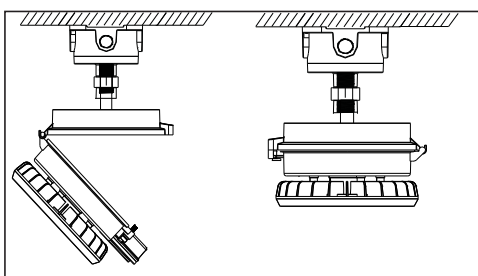

No.7: Stanchion Mounting

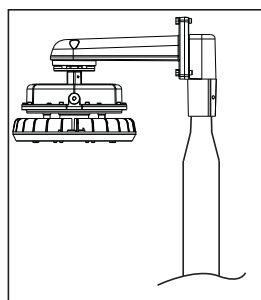

No.8: Wall Mounting

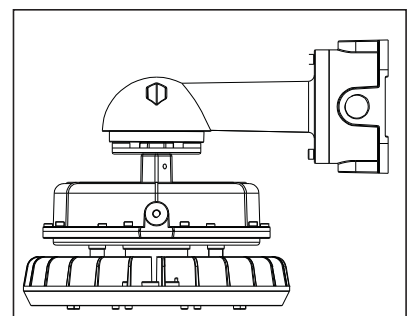

Accessories



- Model: Ex-Junction01
Name: Junction Box
Material: Aircraft Aluminum A383



- Model: EX-Hook
Name: Installation Hook
Material: Aircraft Aluminum A383



- Model: Ex-Conduit01
Name: Metal Conduit
Material: Stainless Steel and Aluminum



- Model: EX-WPipe
Name: Winding Swing Pipe
Material: Iron with Power Coating



- Model: EX-SPipe
Name: Winding Swing Pipe
Material: Iron with Power Coating



- Model: Ex-D01
Name: Pendant Direction Adapter
Material: Aircraft Aluminum A383



- Model: EX-MArm
Name: Surface Mounting Arm
Material: Aircraft Aluminum A383



- Model: EX-25PSupport
Name: 25 Degree Pole Support
Material: Aircraft Aluminum A383



- Model: EX-90PSupport
Name: 90 Degree Pole Support
Material: Aircraft Aluminum A383



- Model: Ex-90JSupport
Name: 90° Arm to Junction box
Material: Aircraft Aluminum A383



- Model: Ex-25JSupport
Name: 25° Arm to Junction box
Material: Aircraft Aluminum A383



- Model: Ex-DArm
Name: Direct Mounting Arm
Material: Aircraft Aluminum A383



- Model: Ex-ShadeB/B2/B3
Name: Lamp Shade
Material: Aluminum A6061



- Model: Ex-CshadeB/B2/B3
Name: Cut off lamp shade
Material: Aluminum A6061



- Model: Ex-Chain
Name: Pendant Chain
Material: Stainless Steel S30400

